

AC INFINITY

IONBEAM

GROW LIGHT BAR SYSTEM

USER MANUAL

SAMSUNG
HORTICULTURE LED



illuminated

Plant-centric
Spectrum

EVO

WELCOME

Thank you for choosing AC Infinity. We are committed to product quality and friendly customer service. If you have any questions or suggestions, please don't hesitate to [contact](#) us. Visit www.acinfinity.com and click contact for our contact information.

EMAIL

support@acinfinity.com

WEB

www.acinfinity.com

LOCATION

Los Angeles, CA

MANUAL CODE NE2302X2

PRODUCT

IONBEAM S11
IONBEAM S16
IONBEAM U2
IONBEAM U4

MODEL

AC-NES11
AC-NES16
AC-NEU11-2
AC-NEU11-4

UPC-A

819137023352
819137023369
819137024090
819137024106

MANUAL INDEX

Manual Index	Page 5
Product Warning	Page 6
Key Features	Page 7
Product Contents	Page 8
Installation	Page 9
Powering and Setup.....	Page 14
Controller Mounting	Page 15
Starter Guide: Full Spectrum Lighting	Page 17
Starter Guide: UV Lighting	Page 19
UIS™ Platform	Page 21
Connecting to UIS™	Page 22
Programming	Page 23
Other Settings	Page 28
Other AC Infinity Products	Page 29
Warranty	Page 30

PRODUCT WARNING



TO REDUCE THE RISK OF FIRE, ELECTRIC SHOCK, OR INJURY TO PERSONS, OBSERVE THE FOLLOWING:

1. Ensure your power source conforms to the electrical requirements of this product.
2. Read all instructions before installing and using this product.
3. Be careful not to damage or cut the wire insulation (covering) during the installation. Do not permit wires to come in contact with any sharp edges.
4. If you are unfamiliar or have doubts about performing this product's installation, seek the services of a qualified, trained, and licensed professional. Inappropriate installation will void this product's warranty.
5. This product must not be used in potentially hazardous locations such as flammable, explosive, chemical-laden or wet atmospheres.
6. Do not cover power cords with rugs or other fabric materials.
7. Safety precautions should be exercised during the installation, operation, and maintenance of this product.
8. Do not block or tamper with this product in any manner while it is in operation as it may cause electric shock, fire, or damage to this product.
9. Do not depend on the on/off programming as the sole means of shutting power from this product. Unplug the power cord before installing, servicing, or moving this product.
10. Do not operate this product while its cord is damaged, or if it malfunctions, has been dropped, or is damaged in any manner.
11. Do not stare directly at the LED lighting fixture. Doing so can cause damage to your eyes and compromise your eyesight. Use UV eye protection when working with ultraviolet lighting.

KEY FEATURES

OPTIMAL LIGHTING*

LED light bars with Samsung LM301H EVO diodes deliver coverage for enhanced light quality over entire grow cycles.

TARGETED LIGHTING†

Select models feature UV LEDs that deliver specialized spectrums to trigger specific grow expressions.

EASY INSTALLATION

Magnetic ends on the LED light bars allow for quick and toolless mounting on any steel surface such as tent frames.

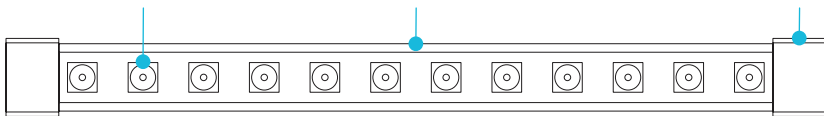

S-series shown



VERSATILE MOUNTING

Cold-rolled steel bars with matte black powder coating provide sturdy bases for placement on any grow tent.

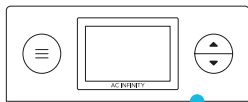

DIGITAL CONTROLLER

Included controller displays OFF, ON, and SCHEDULE modes to activate the ten intensity levels.



UIS™ COMPATIBILITY

Compatible with select UIS controllers to connect with additional lights and access custom programming.

*S-series only

†U-series only

SAMSUNG
HORTICULTURE LED

illuminated

Plant-centric
Spectrum

EVO

PRODUCT CONTENTS

IONBEAM U2 (AC-NEU11-2)



LIGHT BAR
(SINGLE-CORDED)
(x1)



LIGHT BAR
(DUAL-CORDED)
(x1)



MOUNTING
BAR
(x2)



SCHEDULE
CONTROLLER
(x1)



EC POWER
ADAPTER
(x1)



BAR EXTENSION
CORD (M-F)
(x3)



UIS EXTENSION
CORD (M-M)
(x1)



WOOD SCREWS
(WALL MOUNT)
(x7)



CONTROLLER
PLATE BOLTS
(x2)



HEX
NUTS
(x3)



HOOK AND LOOP
CABLE TIES
(x4)



WIRE
MOUNT
(x4)

S-SERIES (AC-NES11, AC-NES16) & IONBEAM U4 (AC-NEU11-4)



LIGHT BAR*
(SINGLE-CORDED)
(x1)



LIGHT BAR*
(DUAL-CORDED)
(x3)



MOUNTING
BAR
(x4)



SCHEDULE
CONTROLLER
(x1)



EC POWER
ADAPTER
(x1)



BAR EXTENSION
CORD (M-F)
(x6)



UIS EXTENSION
CORD (M-M)
(x1)



WOOD SCREWS
(WALL MOUNT)
(x11)



CONTROLLER
PLATE BOLTS
(x2)



HEX
NUTS
(x3)



HOOK AND LOOP
CABLE TIES
(x4)



WIRE
MOUNT
(x8)

*S-series shown

INSTALLATION

LIGHT BAR CHAIN ASSEMBLY

STEP 1

Connect the single-corded LED light bar's female port to the dual-corded LED light bar's male connector.

STEP 2

Connect the EC power adapter's male connector to the other end of the dual-corded LED light bar.

STEP 3

Connect the power adapter to the schedule controller.

EXTENDING THE CHAIN

You may connect the included bar extension cord in between any link in this light bar chain to lengthen it. Secure all connections using the twist-on pieces.

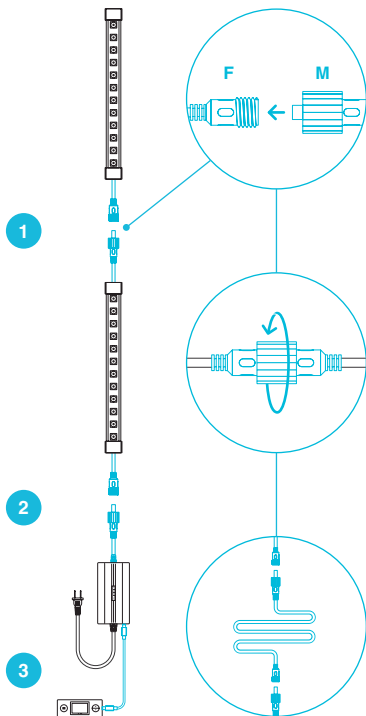

INSTALLATION

LIGHT BAR MOUNTING

POLE MOUNTING

You may magnetically mount the light bar(s) directly on your grow tent steel pole.

You may also use the included hook and loop cable ties around the light bar(s) and mounting bar to adjust the lighting angle and for extra security.

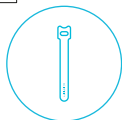
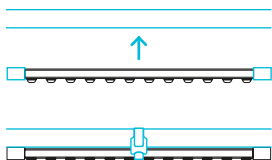

CANVAS MOUNTING

You may magnetically mount the light bar(s) to the wall or ceiling of your grow tent.

Set the included mounting bar(s) on the outer side of your tent. Place the light bar(s) at the exact spot on the inner side.

Once mounted, you can move the light bar and mounting bar connection along your grow tent surface as needed.

Test that the magnetic connection through the canvas is secure before use.

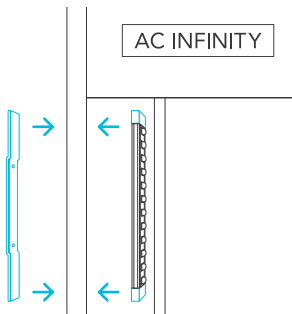

INSTALLATION

LIGHT BAR MOUNTING

STEP 1 — WALL MOUNTING

Make sure your mounting area is free from obstruction. Use a mounting bar to mark your drilling holes with the logo facing the wall.

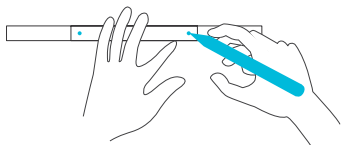

STEP 2 — WALL MOUNTING

Drill holes into the marked locations.

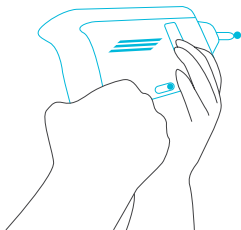

INSTALLATION

LIGHT BAR MOUNTING

STEP 3 — WALL MOUNTING

If you are mounting onto anything other than a wood support or stud, insert the included four wall anchors into the drilled mounting holes.

You may need to use a hammer to secure them through the holes.

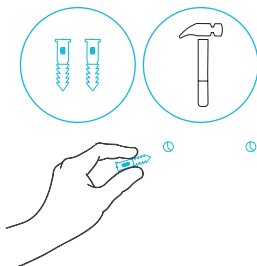

STEP 4 — WALL MOUNTING

Align the mounting bar holes with the wall anchors, making sure the logo faces the wall.

Screw or drill in the wood screws to secure the mounting bar.

Repeat steps 1-4 as needed.

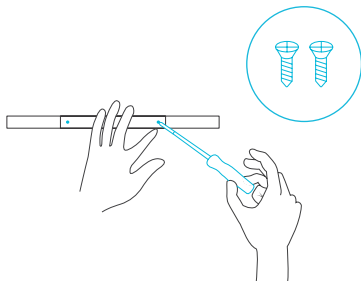

INSTALLATION

LIGHT BAR MOUNTING

STEP 5 — WALL MOUNTING

Set the light bar(s) magnet ends onto the mounting bar(s).



POWERING AND SETUP

STEP 1

Use the included UIS M-M extension cord to connect the fan's EC Motor box to one of the controller's ports.

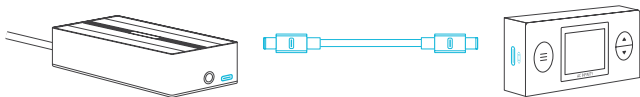

STEP 2

Plug the power adapter into a wall outlet.

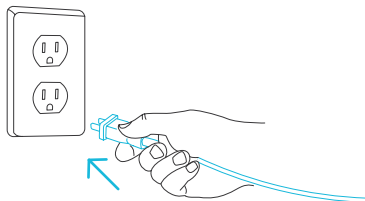

CONTROLLER MOUNTING

STEP 1 — WALL MOUNTING

Locate a spot free of obstruction and secure the anchor into your wall. Twist the wood screw into the anchors.

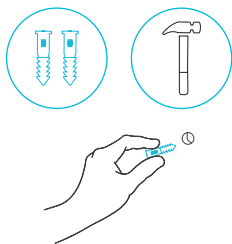

STEP 2 — WALL MOUNTING

Hang the controller by the screw using the holes on the backside.

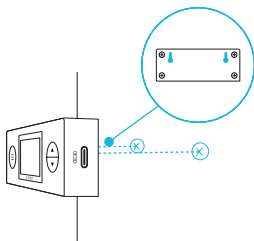

CONTROLLER MOUNTING

MAGNET MOUNTING

The controller will magnetically mount onto the CLOUDLAB series advance grow tent's controller mounting plate or any steel surface.

The magnet is located under the controller's label.

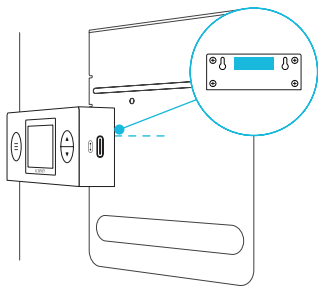
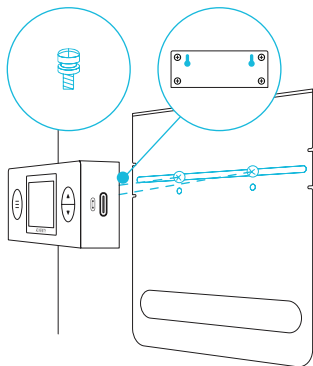

PLATE MOUNTING*

Screw the controller plate bolts into the slot or mounting holes at the upper half of the plate.

Hang the controller by the bolts using the holes on the backside.





*Controller plate not included

STARTER GUIDE

FULL SPECTRUM LIGHTING (AC-NES11, AC-NES16)

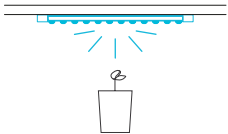

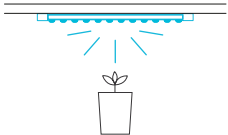
The chart below offers suggested mounting heights and light intensities for each stage in the growing process. These factors will vary based on the plant you are growing. Height refers to the minimum recommended distance from the canopy (tip of the plant) to the light.

GROW STAGE	Height	Intensity	Set-Up
Seedling Stage	1 IN.	<p>Level 1*</p>  <p>10% Brightness</p>	
Vegetative Stage	2 IN.	<p>Level 3</p>  <p>30% Brightness</p>	

*Also recommended for plant propagation.

STARTER GUIDE

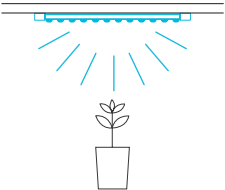
FULL SPECTRUM LIGHTING (AC-NES11, AC-NES16)

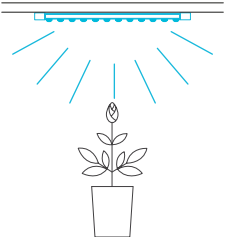







GROW STAGE	Height	Intensity	Set Up
Vegetative Stage	6 IN.	<p>Level 6</p>  <p>60% Brightness</p>	
Flowering Stage	6 IN.	<p>Level 10</p>  <p>100% Brightness</p>	

STARTER GUIDE

UV LIGHTING (AC-NEU11-2, AC-NEU11-4)

Use of UV lighting is recommended only in the flowering stage to enhance fruit and flower development. This lighting can be left on for a few hours a day or the entire daily light cycle.

These factors will vary based on the plant you are growing. Height refers to the minimum recommended distance from the canopy (tip of the plant) to the light.

COVERAGE	Height	Intensity	Models
 2' x 2' 	1 FT.	Level 5  50% Brightness	IONBEAM U2 (AC-NEU11-2)
 2' x 4' 	1 FT.	Level 10  100% Brightness	IONBEAM U2 (AC-NEU11-2)
 3' x 3' 	1 FT.	Level 10  100% Brightness	IONBEAM U2 (AC-NEU11-2)

STARTER GUIDE

UV LIGHTING (AC-NEU11-2, AC-NEU11-4)

COVERAGE	Height	Intensity	Models
<p>4' x 4'</p> 	1 FT.	<p>Level 10</p>  <p>100% Brightness</p>	IONBEAM U4 (AC-NEU11-4)
<p>5' x 5'</p> 	1 FT.	<p>Level 10</p>  <p>100% Brightness</p>	IONBEAM U4 (AC-NEU11-4)

UIS™ PLATFORM

The UIS™ platform enables you to connect a single central controller with several grow devices simultaneously. By creating this fully integrated system, you can power and program all your devices together or separately for optimized grow tent management.

Your grow system can be regulated using your controller hub or remotely on the AC Infinity app (paired with compatible controllers), where you will have access to automation programming and climate data.

You can also connect your favorite grow light and outlet device to integrate them into the UIS platform using our RJ11/12 adapter and control plug module.

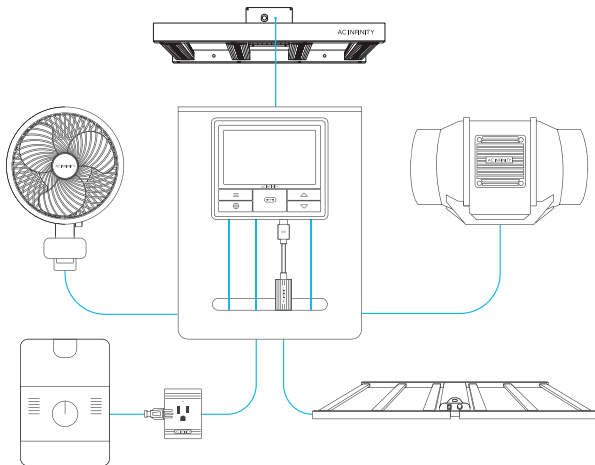

Central controller and grow devices will be sold separately and may still be in development at the time of your purchase of this product.

CONNECTING TO UIS™

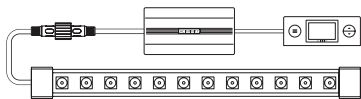

IONBEAM LED grow lights can connect with select smart controllers as part of an integrated system using the included UIS extension cord.

CONNECTING TO UIS CONTROLLERS

Use the included UIS M-M extension cord to connect the EC power adapter to your selected UIS controller.

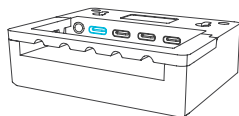
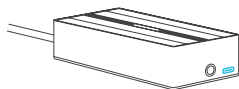
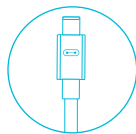

CONTROLLER 69 PRO (CTR69P) shown

PROGRAMMING

1. MODE BUTTON

Cycles through each of the controller modes: OFF, ON, SCHEDULE, SUNRISE/SET, and CLOCK. Holding this button will lock the controller; pressing this button afterwards will turn off the display.

2. UP/DOWN BUTTON

Adjusts the setting of your current mode.

3. CURRENT TIME

Displays the current time. The internal battery sustains the clock so it does not default to 00:00 if power is cut off.

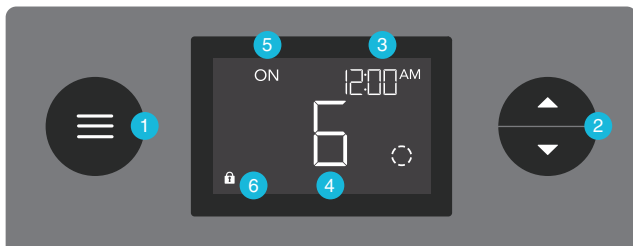

4. USER SETTING

Displays the grow light's intensity level as well as countdown timers of the SCHEDULE modes.

5. CONTROLLER MODE

Displays the controller's current mode. Pressing the mode button cycles through the available modes.

6. LOCK ICON

Displays the controller lock status of the controller.

PROGRAMMING

CONTROLLER MODES

Pressing the mode button will cycle through the controller's available programming modes and settings: OFF, ON, SCHEDULE, SUNRISE/SET, and CLOCK.

OFF MODE

Your grow light will not activate while in this mode. The intensity level set here establishes the minimum intensity level in the SCHEDULE mode. When it is triggered to turn off, it will instead shine at the level set here.

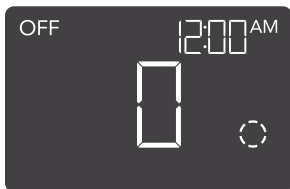

ON MODE

Your grow light will activate to the intensity level set here. The ON mode also serves as the maximum intensity level the SCHEDULE mode will shine in.

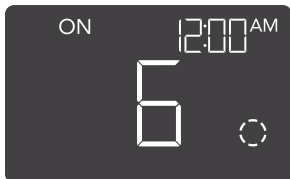

PROGRAMMING

SCHEDULE MODE (ON & OFF)

Sets an on clock-time and an off clock-time schedule for your grow light to follow daily.

Press the up or down button to first set up an on clock-time to turn your grow light on, then press the mode button to set an off clock-time to turn your grow light off. Please be sure to set the current clock time under settings.

When your grow light turns on, it will run at your set maximum level. When your grow light turns off, it will run at your set minimum level.

The countdown will begin if no buttons are pressed for 5 seconds. Leaving the SCHEDULE mode while the countdown is running will pause it until you return to this mode.

Resetting the off clock-time will result in your grow light staying on until you actively turn it off.

The grow light will shine at your set OFF mode level while it is off, and at your set ON mode level while it is on.

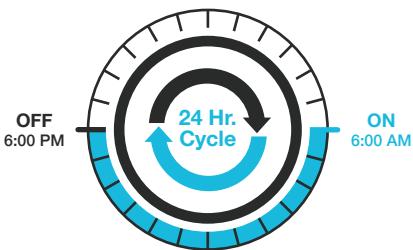
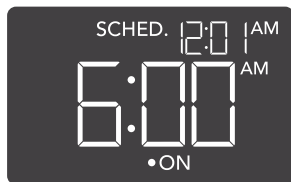

PROGRAMMING

SUNRISE/SET SETTING

Sets a sunrise and sunset time for your grow light to brighten and dim, respectively. This setting only applies to SCHEDULE mode.

Press the up or down button to set a duration between 0:00 – 6:00 hours for your grow light to brighten and dim. For this setting to activate, you must return to SCHEDULE mode.

When your grow light is triggered to turn on, it will begin brightening up to your maximum level. It will then begin dimming down to your minimum level before it is triggered to turn off.

In this example, your grow light is set to turn on at 6:00 AM and turn off at 6:00 PM. The SUNRISE/SET setting is set to 2:00 hours. At 6:00 AM, your grow light will begin gradually brightening until it reaches your maximum level at 8:00 AM. Your grow light will then begin dimming at 4:00 PM until it reaches your minimum level at 6:00 PM.

You may deactivate this mode by setting the SUNRISE/SET timer to 0:00.

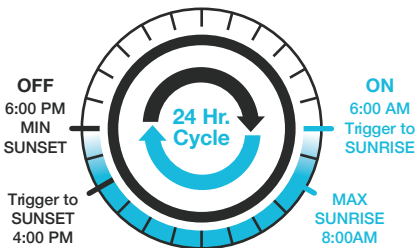
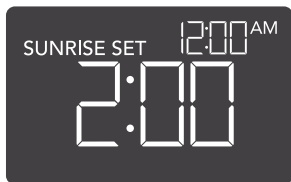

The grow light will shine at your set OFF mode level while it is off, and at your set ON mode level while it is on.

PROGRAMMING

CLOCK MODE

Adjusts the current clock time. Use the up and down buttons to adjust the time. Once you cycle through 12:00 each time, the units will automatically change to AM or PM.

The clock time is located at the center of the display and the upper right hand corner.



TOGGLING THE DISPLAY

Lock the controller by holding the mode button.

Press the mode button to turn the display off. Pressing the mode button again will turn the display back on.

Programs will still run in the background while the LCD screen is off.



HOLD + 



PRESS + 

OTHER SETTINGS

FACTORY RESET

Holding the mode and up/down buttons together for 5 seconds will reset your controller and restore factory settings. This will clear all user set parameters of each controller mode and setting.

HOLD +



RESET TO OFF/DEFAULT

Holding the up and down buttons together for 2 seconds will reset the value of your current mode to its default setting. In SCHEDULE mode, pressing the up or down button after resetting will return it to its previous value.

HOLD +



CONTROLLER LOCK

Holding the mode button will lock the controller in your current mode. While your controller is locked, no parameters may be adjusted nor will you be able to switch modes. Holding the mode button again will unlock the controller.

HOLD +



HIDE SCREEN

Lock the controller so no settings can be adjusted. See above. Then press the mode button to turn the display off. Pressing the mode button again will turn the display back on. Programs will still run in the background while the LCD screen is off.

PRESS +



AC INFINITY PRODUCTS

Advance Grow Tents

The CLOUDLAB series is a line of grow tents designed to create ideal growing conditions and facilitate indoor plant cultivation year-round. Features 2000D thick oxford canvas lined with inner diamond patterned mylar that maximizes grow light luminosity, and a reinforced frame with 150 lb. weight capacity. Includes a mounting plate to install your AC Infinity controller onto.

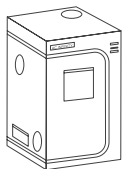

Humidity Dome

The humidity dome is designed to maintain moisture levels to create the ideal environment for seed germination. Each kit includes a base tray and seedling tray with a dome that is built with adjustable vents to control humidity levels. Height extender also included to provide a higher ceiling for propagation applications.

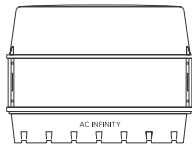

Seedling Mats

The SUNCORE series is a line of seedling mat designed to improve germination success and accelerate your seeds' growth process by emitting steady heat. Each mat is lined with an innovative far-infrared film that provides even heating distribution.



Discover the latest innovations in environmental controls at acinfinity.com

WARRANTY

This warranty program is our commitment to you, the product sold by AC Infinity will be free from defects in manufacturing for a period of two years from the date of purchase. If a product is found to have a defect in material or workmanship, we will take the appropriate actions defined in this warranty to resolve any issues.

The warranty program applies to any order, purchase, receipt, or use of any products sold by AC Infinity or our authorized dealerships. The program covers products that have become defective, malfunctioned, or expressively if the product becomes unusable. The warranty program goes into effect on the date of purchase. The program will expire two years from the date of purchase. If your product becomes defective during that period, AC Infinity will replace your product with a new one or issue you a full refund.

The warranty program does not cover abuse or misuse. This includes physical damage, submersion of the product in water, incorrect installation such as wrong voltage input, and misuse for any reason other than intended purposes. AC Infinity is not responsible for consequential loss or incidental damages of any nature caused by the product. We will not warrant damage from normal wear such as scratches and dings.

Contact our dealers department at dealers@acinfinity.com or (626) 838-4656 for more information about our dealers and distributors program. Contact our customer service department at support@acinfinity.com or 626-923-6399 for product and warranty assistance. Our business hours are Monday through Friday, 9:00 am to 5:00 pm PST.



If you have any issues with this product, contact us and we'll happily resolve your problem or issue a full refund!

COPYRIGHT © 2023 AC INFINITY INC. ALL RIGHTS RESERVED

No part of the materials including graphics or logos available in this booklet may be copied, photocopied, reproduced, translated or reduced to any electronic medium or machine readable form, in whole or in part, without specific permission from AC Infinity Inc.

www.acinfinity.com